



American Kitefliers Association

KITES IN THE CLASSROOM

REVISED EDITION

by Glenn Davison

Copyright © 2002
Glenn Davison

Thanks to all those who helped to make this edition a reality including
Archie Stewart, Bev Lindemann, David Gomberg, Hank Manseau,
Janis Worth, Ollire Lane, Ralph Reed, Wayne Hosking, and my wife Misao.

First Edition by Wayne Hosking, Copyright © 1992

Published by:
American Kitefliers Association
P. O. Box 1614
Walla Walla, WA 99362, USA
(800)AKA-2550
<http://www.aka.kite.org/>

CONTENTS

1	PREFACE	1
2	GIVING A PRESENTATION	2
3	CONTENT BY GRADE LEVEL	3
4	EXAMPLE OF PRESENTATION OUTLINE	4
5	MORE KITE PROJECTS	5
6	HISTORY	7
7	WHAT IS A KITE?	11
8	PARTS OF A KITE	12
9	KITE STYLES	13
10	MATERIALS	15
11	PHYSICS OF KITE FLIGHT	17
12	MATHEMATICS	19
13	FLYING A KITE	21
14	SAFETY	22
15	RUNNING A WORKSHOP	23
16	WORKSHOP KITES TO BUILD AND FLY	24
17	APPENDICES	39

PREFACE

Kites in the Classroom is designed to help you promote the world of kiting to an audience in a classroom setting. This may be the first real experience for many people with a kite. Your audience may not be familiar with the wide variety of kiting activities that exist today, or the variety of kites available to build or purchase.

The goal of *Kites in the Classroom* is to serve as a blueprint for organizing successful events that explore unique and exciting kiting adventures and activities. It outlines the details for giving educational **presentations**, and hands-on **workshops**. It provides information that is both educational and practical while it includes suggestions that can be applied for people of all ages and various levels of schooling, from preschool through retirement.

The kiting world has changed over the years. Kiting has become an active, passionate sport with regular events like festivals and competitions. It's a hobby for some, an amusement for many and both rich and culturally diverse in nature.

From an educational perspective, kites make a terrific vehicle for learning about a variety of subjects. Topics can range from creative uses of graphics and colors, all the way to history, physics, aerodynamics, and mathematics - from crafts to fine art, as well as exploring the more inspirational thoughts associated with kite flying.

From a practical perspective, *Kites in the Classroom* will give you the tools for providing details about the mechanics of a kite, the art of flying, and the creativity involved in building a kite. For hands-on applications, there are a variety of kite plans included for building inexpensive kites as well as resources for detailed investigations.

The information that you provide will help people have more rewarding experiences. You can eliminate some of the frustration that occurs when the basics of building or flying a kite are unknown or unclear while you stimulate ideas about what is possible.

So, share your knowledge and bring kites into the classroom! It's a wonderful way to encourage others to learn about and participate in these wonderfully rewarding experiences.

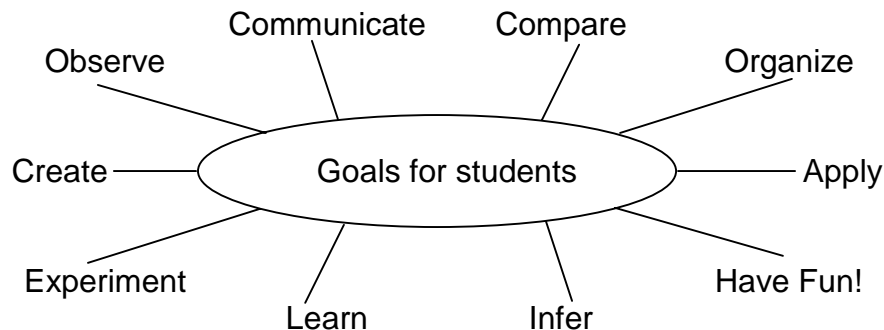

GIVING A PRESENTATION

If you plan to give a talk about kites, this book will help you to make it as much fun as possible. Prepare examples of different kites. Bring pictures, magazines, books, plans, photographs, and illustrations as well as samples of materials such as spars, lines, and sails.

Extend an invitation to local kite fliers to visit, demonstrate, and participate in your event. Ask them to show and talk about their kites and you'll get an enthusiastic response! Kite fliers love to share their experience and knowledge and entice others to participate. You can find clubs in your area through the American Kitefliers Association. See the appendix for contact information.

Keep everyone interested by giving many examples and demonstrations during your talk, perhaps one every few minutes.

Suggestion: Ask your students to bring in their own kites.

Suggestion: Prepare for your talk by setting up a display of many different styles of kites. Having kites from various countries adds a great feeling of worldwide community.

Suggestion: Advise your kite flying visitors to share their knowledge appropriately. Ask them not to talk too much but to ask questions instead. They should encourage participation. Their goal is not only to share their knowledge about kites, but to inspire your students to think, observe, and learn.



CONTENT BY GRADE LEVEL

With the information in this book, you will be able to deliver a lesson that is designed for your time constraints, your budget, and your audience.

Background topics for a **presentation** about kites:

1. History
2. What is a kite?
3. Kite styles
4. Parts of a kite
5. Materials used
6. Flying demonstrations

Additional topics for upper grade levels:

- For 9th grade and above, add Kite Design.
- For 10th grade and above, add the Physics and Mathematics of kite flight.
- For 11th grade, add Earth Science.

After a presentation, your students will be interested and excited to do a **workshop**:

1. Kite building
 - a. preparation
 - b. setup
 - c. kite building
 - d. clean up
 - e. kite safety
2. Kite flying

If you'd like to do it all in one session, reserve at least a day for:

1. A presentation about kites with extra time for questions
2. A kite building workshop
3. Kite flying

You may wish to broaden your curriculum from "kites" to cover the broader topic of "flight" including aircraft, aeronautics, and everything from feathered flight to space exploration.

Suggestion: Most states have an educational curricula that may help you to fit your lessons into the national educational standards for English, Math, Science, Social Studies, etc.

Suggestion: Following an outline can keep you on track. Use the outline on the next page as an example.

EXAMPLE OF PRESENTATION OUTLINE

Introduction

- Introduce the topics that you will cover
- Explain that modern kite activities include: national competitions for both building and flying, flying kites on ice, tiny kites, giant kites, power kites, fighter kites, night flight with lights, indoor flying, multi-line kites, and much more
- Ask students to talk about their kite experiences

History, Social Studies, Geography

- Kites were used for fishing, to study the weather, and on the battle field
- The first airplane was a kite before it was an airplane
- A kite lifted the antenna during the first transatlantic radio transmission
- Many countries have their own kite styles

What is a kite?

- Heavier than air
- One or more surfaces to provide lift
- Must be tethered to be a kite

Parts of a Kite

- Anatomy of a kite: line, bridle, sail, spars

Kite Styles

- Flat, bowed, foil, fighter, cellular, multi-line, etc.

Materials

- Weight and strength
- Sail, frame, line

Physics and Mathematics of kite flight

- Forces that act on a kite
- How kites fly

Flying a Kite

- Launching and flying
- Stunt kites

Safety

- Where to fly safely
- Dangers to avoid

Flying Demonstrations

- Indoors and outdoors

MORE KITE PROJECTS

The applications of kites are extremely broad, so be creative when discussing each subject. Encourage further investigations. It will make your job easier, varied, and more exciting. We all know that children learn better with the "hands on" approach.

- | | |
|--------------------|----------------------------------------------------------------------------------------------------------------------------------------------------------------------------------------------------------------------------------------------------------------------------------------------------------------------------------------------------------------------------------------------------------------------------------------------------------------------|
| Art | <ul style="list-style-type: none">• Decorate a kite with markers, paint, printing, applique.• Build a flying sculpture with many cells.• Build a figure kite in the shape of a chosen animal. Decorate the kite to match the shape. |
| Community Service | <ul style="list-style-type: none">• Build and fly kites with residents of a retirement community. |
| Computer Science | <ul style="list-style-type: none">• Search the web for "kite history," "kite plans," "kite styles," "Japanese kites," "Indian fighter kites," "bamboo kites," and so on. |
| Crafts | <ul style="list-style-type: none">• Students can build a simple kite from a kite from one of the plans in this book.• Double the size of a kite and build it.• Build a complex kite independently.• Sew a kite from a kite plan.• Practice tying knots such as the overhand, larks head, and prussik. |
| Design | <ul style="list-style-type: none">• Build a kite of your own design so it actually flies. |
| Earth Science | <ul style="list-style-type: none">• Track wind speed and weather conditions.• Identify the percentage of a week or year that is ideal for kite flying. |
| History | <ul style="list-style-type: none">• Research how kites were used in battle.• Research the use of kites by the Wright Brothers.• Research the varied use of kites throughout the history of flight. |
| Industrial Science | <ul style="list-style-type: none">• Build a simple balance that will allow you to compare two materials to determine which is lighter. A simple coat hanger will work. Students can experiment to improve the accuracy of the balance.• Design and build a scale that will measure the pull on a kite line.• Design and build a kite "line winder" from wood. Advanced: build a winder using bearings to retrieve the line smoothly. |
| Mathematics | <ul style="list-style-type: none">• Change the size of a kite, scaling all pieces proportionately.• Calculate the ratio of weight to sail area for a variety of kite styles.• Measure the size of a kite and calculate its aspect ratio.• Discuss symmetry and geometry using kites.• Convert the measurements from English to Metric. |
| Music | <ul style="list-style-type: none">• Find songs about kites or kite flying.• Choreograph and perform a kite flying routine where you synchronize the kite's movements to music. |
| Physical Education | <ul style="list-style-type: none">• Learn to set up, launch, and fly a stunt kite.• Perform precise maneuvers with a stunt kite such as a "box" or "staircase." |

- Physics
- Calculate the tension on a kite line based on wind speed.
- Reading
- There are many books ranging from "Curious George Flies a Kite" to the aerodynamics of flight.
- Science
- Move the tow point higher and lower. Predict and measure results.
 - Examine fibers of thread (and fabric) under a microscope.
 - Study kite aerodynamics. Discuss changes for heavy or light wind.
 - Move the spine to one side or add more sail to one side. Predict and measure the results.
- Social Studies
- How have kites been used by people worldwide?
 - Which kites are specific to which regions of the world?
 - How are kites are used in other countries?
- Trigonometry
- Calculate the kite's altitude based on the length of the line and the angle of flight above the horizon.
 - Calculate the length of line necessary to reach 2000' at an angle of 33 degrees without sagging.
- Vocabulary
- Name the parts of a kite.
 - Name kite styles.
 - Review the glossary in this book.
- Writing
- Write a short story or poem.
 - Correspond with a kite club overseas by email.
 - Create a book of stories, poems, photographs, and drawings.



HISTORY

Early Kite Adventures

Though the exact origin of kites are not known, it is known that they were flown in China and the Malay Archipelago two to three thousand years ago.

The earliest written accounts of kite flying were the exploits of the Chinese general Han Hsin, Han Dynasty (206 B.C.-220 A.D.). During one military campaign, the general was said to have had a kite flown above a besieged town to calculate the distance his army would have to tunnel to reach under the city wall. Knowing the exact measurement, his troops surprised their enemy and were victorious.

The popularity of kite flying spread from China along trade routes to Korea, India, and Japan. They arrived in Korea in the period of the Three Kingdoms (4-645 A.D.). During the Silla dynasty (595-673 A.D.), General Gim Yu-sin was ordered to subdue a revolt. However, his troops refused to fight after a large shooting star appeared to have fallen from the sky. It was believed that this was a bad omen. To regain control, the next night the general had a kite carry a fire ball into the sky where it disintegrated. His troops, seeing the shooting star returning to the sky, rallied and routed the rebels.

Kites were brought to Japan around the 7th century by Buddhist monks. They were used as magical figures or "talismans" to avert evil spirits and as invocations for a rich harvest. In the Edo Period (1603-1868), kite flying became very popular when, for the first time, Japanese people below the samurai class could fly kites. The Edo (now Tokyo) government tried unsuccessfully, to discourage this pastime because "too many people became unmindful of their work."

In 1712, a thief named Kakinoki Kinsuke is said to have used a large kite to carry himself to the top of Nagoya Castle. There, under the cover of darkness, Kinsuke stole the scales from a pair of golden dolphin. The luckless Kinsuke boasted of his exploits and was captured and boiled in oil.

The first lighter-than-air balloon was flown in 1783 and the first powered aircraft took flight in 1903. These are very recent when compared with the age of kites.

Indian Experiences

The earliest evidence of Indian kite flying can be seen in miniature paintings from the Mogul Period (1483-1530). A favorite theme was of a young lover skillfully dropping his message-bearing kite onto a roof top and into the hands of his waiting love, where his fair maiden was held in strict seclusion from the outside world.

Fishing With Kites

We know from early accounts that the people of Micronesia had known about kite fishing for centuries. A leaf kite allowed bait, made from a thick loop of spider's web, to be placed on the surface of the water where the gar-fish fed. A fish was snared when its long snout became entrapped by the loop.

Dueling With Kites

The Polynesians also have a long kite history. One of their myths tells of two brother gods, Tan and Rango, who introduced kites to man when they challenged each other to a kite duel. The bout was short lived because young Tan's kite became entangled in a tree while Rango's flew free and high. Today, in celebration of the event, the person whose kite flies the highest is honored by having his kite dedicated to Rango.

The earliest Malay reference to kite flying comes from the 15th century Malay Annals. Rajah Ahmad, the eldest son of Malacca's Sultan Mahmud, once cut all the kites from the sky with a large kite, flown from strong fishing twine. The next day the Rajah went through the same process until he found Hang Isa Pantas's smaller kite. Unknown to the Rajah, Hang had applied jungle gum and powdered glass to his twine. When the two lines crossed, the Rajah's parted and his kite tumbled to the ground.

Around the end of the 13th century, stories of kites reached Europe via Marco Polo. European illustrations of the period show dragon or pennant-shaped kites based on non-flying, three dimensional, Roman military banners. Later, in the 16th and 17th century, Europeans, most prominently the Dutch, found a sea route around the Cape of Good Hope and began trading throughout the East Indies. It was through their contacts with the Malay Peninsula that the fore-runner of today's diamond kite was introduced to the west. Because they were regarded as curiosities, kites at first had little impact on European culture.

Research With Kites

In the 18th and 19th centuries, kites were used as vehicles for discovery. Men like Ben Franklin and Alexander Wilson applied their knowledge of kite flying to gain a greater understanding of the elements such as electricity. Others, such as Sir George Cayley, Samuel Langley, Lawrence Hargrave, the Wright Brothers, and Alexander Graham Bell experimented with kites and contributed to the evolution of the airplane. The U.S. Weather Bureau flew kites designed by William Eddy and Lawrence Hargrave to raise meteorological instruments.

Pull A Carriage

One of the strangest uses of kite power was developed in 1822 by George Pocock, a U.K. schoolmaster. Pocock created a carriage pulled by a pair of arch top kites. His "char-volant" was capable of speeds of up to 20 miles per hour. The kites were flown

in tandem and steered by four independent lines. Since the road toll was based on the number of horses pulling a carriage, this horseless rig was ruled exempt from road tolls because no animals were used.

The Airplane

After years of research and experimentation, the Wright Brothers tested their flying-machine as a kite before they flew it as the first manned airplane in 1903. As the airplane became firmly established, there is little evidence to show that kites were used other than for recreational flying. The main styles of kites flown for the next fifty years were the 3-stick Barn Door, the Diamond, and the Box kite.

Military Kites

The doldrums in kite development were broken for short periods by World War I (1914-1918) and World War II (1939-1945). World War I created a practical use for trains of man-lifting kites. The British, French, Italian, and Russian armies all had kite units for enemy observations and signal corps. The introduction of military airplanes quickly made these units obsolete. The German Navy also used man-lifting box kites to increase their viewing range from surface cruising submarines. In World War II the U.S. Navy found uses for kites such as Harry Saul's Barriage Kite (anti-aircraft), the Gibson-Girl Box Kite (air rescue), and Paul Garber's Target Kite (target practice and aircraft recognition). As in World War I, the German Navy sent observers aloft from surfaced submarines, but this time they used highly maneuverable rotating, gyroplane kites.

Recent Kite Adventures

Since World War II there has been renewed interest in kiting. For example, two of this century's greatest kite innovations, Rogallo's flexi-wing (1948) and Jalbert's parafoil (1964) kites, helped develop the modern hang-gliders and sports parachutes, respectively. In 1972, Peter Powell from England made the dual line stunt kite popular. This led to the public's awareness that kiting could be a "sport" and not just "child's play." With the "kites are for kids" stigma removed, many adults (and children) are again enjoying this healthy, active pastime. The renaissance in the west has led a number of Asian countries to revive their own kiting heritage.

Today

Kite flying is a worldwide sport, recreation, and pastime for thousands of people - from the very young to the eldest, in almost every culture. There are regular kite festivals celebrated annually. There are national and international kite competitions for single-line, dual-line, and quad-line kites. Kites are used for traction on snow, ice, water, and land reaching speeds of more than 40mph. Kites are regularly used for science, artistic expression, celebration, and decoration.

HISTORIC KITE EVENTS

Write these words for your students: "Niagara Falls, weather research, electricity, radio, photography, and airplanes." Ask them how kites played a part in each one.

- 1749 Alexander Wilson flew a kite train to record air temperatures at different altitudes.
- 1752 Ben Franklin proved there was electricity in lightning.
- 1804 George Cayley developed the concept of heavier-than-air flight. His glider was a modified arch top kite.
- 1827 George Pocock used kites to pull a horseless carriage.
- 1847 A kite flown by Homan Walsh, age 10, aided in the construction of a suspension bridge across the Niagara River.
- 1893 The Eddy Diamond and the Hargrave Box raised scientific instruments for weather research.
- 1899 The Wright Brothers used kites to test their theories for the first flying machine (airplane).
- 1900 Guglielmo Marconi used a kite to lift an antenna to make his historical radio link between America and Europe.
- 1901 The French Military (Conyne) kite raised military observers.
- 1903 The Wright Brothers flew the first manned flying machine.
- 1903 A kite train towed S.F. Cody across the English Channel.
- 1906 Kites carried a camera aloft to take aerial photographs of the damage caused by the San Francisco earthquake.
- 1907 Dr. Alexander Graham Bell lifted his wife off the ground using a kite made of over 3,000 tetrahedral cells.
- 1919 A kite train was flown in Lindenberg, Germany to an altitude of 31,955 feet.
- 1939-1945 The Gibson Girl Box, Garber's Target Kite, and Saul's Barrage Kite were all used in World War II.
- 1948 Francis Rogallo patented his Flexi-wing kite. It was the forerunner of the hang glider and delta kite.
- 1964 Domina Jalbert designed the parafoil. His concepts have been adapted for parachutes and kites.
- 1972 Peter Powell introduced his dual line stunt kite.
- 1978 Kuzuhiko Asaba flew 4,128 kites on a single line.
- 1989 Kite flying becomes a sport with the establishment of a national stunt kite circuit. The "California Swept Wing" stunt kite has had the greatest influence on stunt flying.

WHAT IS A KITE?

Challenge your students to come up with a definition for a kite. Ask, "Class, what is a kite?"

Amazingly enough, this question will probably stump your class. Everyone knows what a kite is visually, but many have difficulty explaining it clearly and concisely in words.

You can stimulate the discussion with the question, "If you had a friend that lived on the moon, and they had never seen a kite, how would you describe it?"

Your Students Might Say	You Can Ask Them
It's a toy	How is it different from a rubber ball?
It can fly	How is it different from an airplane?
It rises in the air	How is it different from a balloon?
It uses the wind	How is it different from a windmill?
It has paper or fabric	How is it different from your shirt?
It has sticks	How is it different from a fan?
It's lightweight	How is it different from a feather?

Look for the following key ideas that usually come from different students and can stimulate additional topics for discussion:

- Kites are tethered objects using one or more lines
- Kites depend on air moving across their surfaces to fly
- Kites generate lift and have an aerodynamic shape

Definition:

According to the Drachen Foundation in Seattle, WA, "A kite is a heavier-than-air craft that depends on the wind to overcome gravity to fly. All kites have one or more surfaces to be acted upon by the wind, a bridle to hold the kite at an efficient angle into the wind, a flying line to keep the kite from blowing away."

PARTS OF A KITE

Suggestion: Have multiple kites on display and discuss the function of each part.

<i>Bridle</i>	Keeps the kite at the proper angle to the wind and often supports the kite at multiple points
<i>Fittings</i>	These include stick to stick fittings and stick to fabric fittings such as: glue, tape, or pockets
<i>Keel</i>	Similar to a bridle, acts like a rudder
<i>Line</i>	Prevents the kite from flying away, thicker line is stronger and the strength is measured in pounds
<i>Sail</i>	Directs the air to give lift
<i>Spars</i>	Give a kite structure, some have special names like "spine" and "spreader"
<i>Tail</i>	Adds drag to keep the kite pointed into the wind
<i>Tow point</i>	Connection point from the line to the bridle

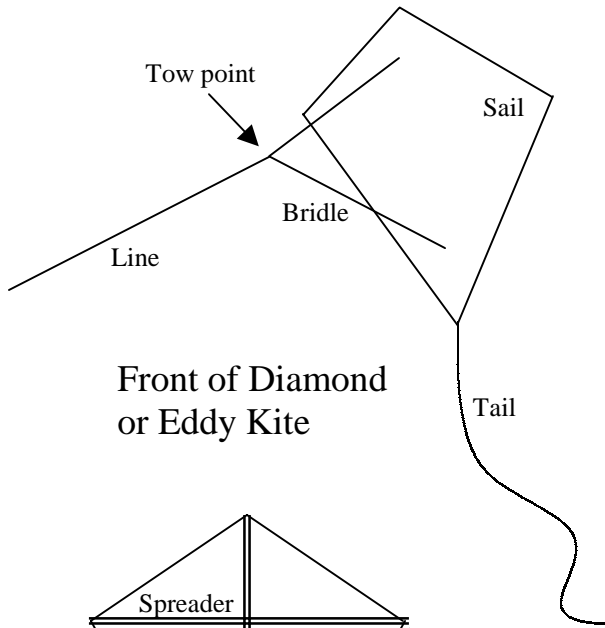

Front of Diamond or Eddy Kite

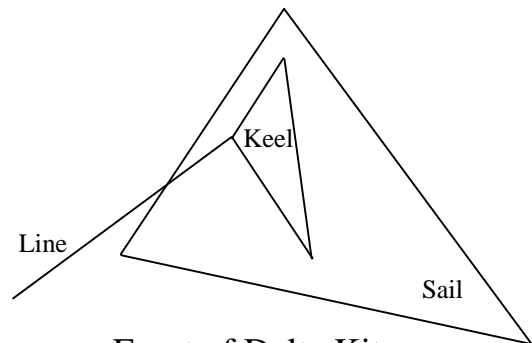

Front of Delta Kite

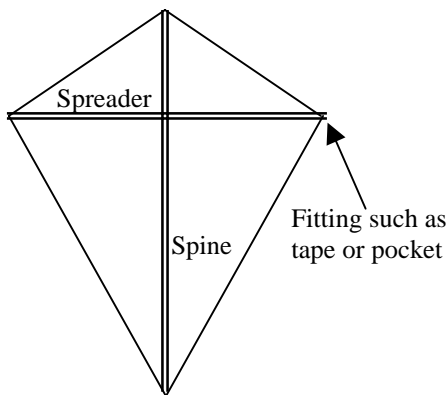

Back of Diamond or Eddy Kite showing spars

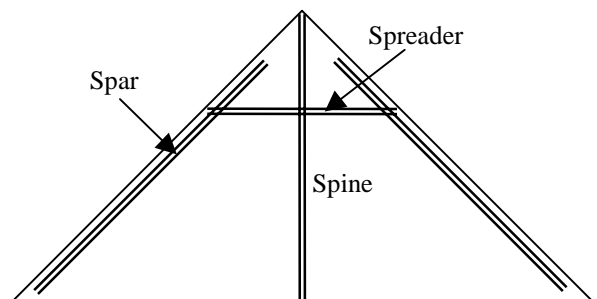

Back of Delta Kite showing spars

KITE STYLES



There are a multitude of different kite styles that are flown today. Hundreds of different styles exist and can be seen on the web or at kite festivals nationwide.





Suggestion: Display examples or pictures of different kite styles from books, magazines or the web.

Suggestion: Discuss the differences between kite styles. Some kites:

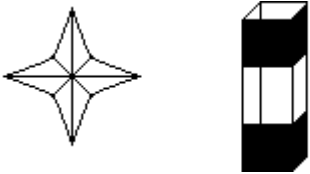
- use keels, others use bridles
- use sticks, while others have none
- have tails, others don't need them
- are flat, some are bowed
- vary in size from under two inches to more than 12 feet wide
- use construction materials that vary in weight and strength
- have one, two, or four control lines

Some styles include:

Kite Style	Examples	
Flat		Snake, Hexagonal, Diamond, Delta
Bowed		Eddy, Edo, Rokkaku
Cellular		Star, Box Kite

Multi-line		Dual-line Stunt Kite, Quad-line Stunt Kite
Fighters & Flexible		Hata, Indian Fighter, Korean Fighter
Figure		Bird, Bat
Soft		Soft Airfoil, Parafoil, Flowform
Stacks and Trains		Single-line train of Kites, Dual-line stack of kites
Others	Many other styles and variations exist!	

MATERIALS

There are many lightweight materials that can be used to build kites. Most kite sails are nylon, polyester, paper, or plastic. Most kite spars are wood, fiberglass, plastic, or carbon. The best kite materials are lightweight and strong, but materials vary widely in their weight and strength so students must choose carefully.

Weight of Materials

In a vacuum, all materials fall at the same rate. When air is introduced, some materials "float" better than others because they are both lightweight and non-porous.

Demonstration: Drop various pieces of paper from shoulder level to the floor. The pieces should be identical in size but each should be a different thickness such as cardboard, writing paper, wrapping paper, and thin tissue paper. As an alternative, use a feather and a marble. The intent is to show your class that wind resistance allows lighter materials to fly better.

Strength of Materials

Demonstration: Get a sheet of spun-bonded olefin from the tough envelopes at your post office. Cut pieces that are about two inches square. During your talk, explain how some materials are stronger than others even though they have the same weight. Distribute the pieces of the spun-bonded olefin and challenge students to tear it in half while you tear an identical piece of writing paper in half. Theirs won't tear while yours will tear easily, proving your point that materials that look similar can be much different in strength. Explain that stronger materials add weight and may affect how it flies.

Where to purchase materials:

Item	Location
Sails	Trash bags make great sails - available at supermarkets & hardware stores
	Trash bags: (800)527-7189 - Ask for a kite selection (100 box - 4 colors)
	Trash bags - Bland Co., 4265 Corporate Dr., Mt. Pleasant, MI 48858
Spars	Wooden dowels are available from your local hardware store or hobby store
	Wooden dowels in bulk (800)242-9663, (\$50 Minimum)
	S & S Wood Specialty, P.O. Box 1188, Westbrook, ME 04098
	Match-stick Bamboo is available from wooden blinds, available from Pier 1 Imports. Ask for damaged ones that may be cheaper.
Tails	Rolls of plastic "Surveyor's tape" or "flagging tape" make great tails. They are not sticky and are available from most hardware stores
	Crepe paper is available from any party supply store
String or line	Available by the box from Gayla Industries in Houston, TX or from Richard Dermer, 121 S. McFarland, Stillwater, OK 74074, Phone: 405-372-6127, Fax: 405-377-7763, e-mail: tbkahuna@swbell.net
Tape, glue, markers	Supermarkets, hobby supply, art supply, discount, or office supply stores
Nylon fabric, polyester fabric, carbon rods, fiberglass rods, fittings	For more durable kites, these materials are available online or at kite shops. To locate them, use the "Internet Resources" section below or look in any issue of <i>Kiting The Journal of the AKA</i> . http://www.aka.kite.org/

Use the following suggestions in your classroom to display kite materials. Discuss which are used for larger kites and which are used for heavy wind or light wind. Explain that thicker sticks are not always stronger or stiffer than thinner ones.

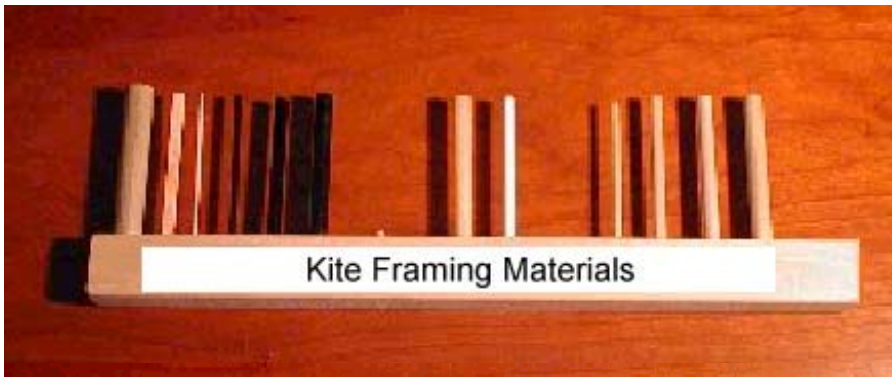

Suggestion: Make a display of kite framing materials. Drill holes into a long strip of wood and insert examples of different frame materials such as bamboo, fiberglass, carbon fiber, and wooden dowels. Examples should include solid and hollow rods.



Suggestion: Make a display of kite lines. Make holes around the perimeter of a piece of cardboard. Attach a different strength line in each. Label each.

Suggestion: Make a display of kite sail materials. Use nylon, polyester, tyvek, mylar, a garbage bag, tissue paper, and wrapping paper. Label each.



PHYSICS OF KITE FLIGHT

A single-line kite forms a stable and self-adjusting system while in flight. The moving air creates lift and the kite rises. A kite flies because it is spilling air downward to give it lift, and outward to give it stability. Think of the air like lots of small pellets bouncing off the kite or like waves of water being pushed away by the kite, just like the hull of a boat pushes away water.

Forces at Work on a Kite

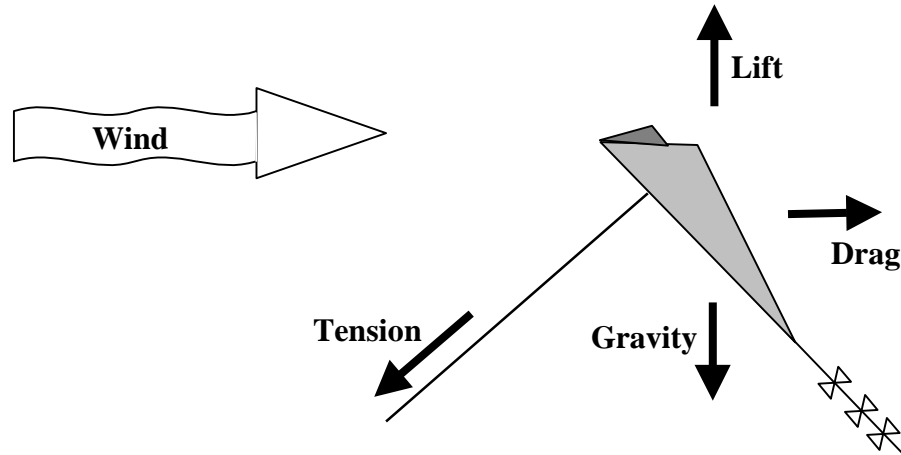

Forming a Stable System

How does a kite become stable? To provide stable flight, the kite must have some aerodynamic shape that can equalize opposing forces: lift vs. gravity, roll/pitch/yaw, and lift + drag vs. line tension.

Lift vs. Gravity

Explain to your students that all objects exert gravity on each other. The earth just happens to be the largest and closest. Explain that kites generate lift to counteract the force of gravity and find an equilibrium.

There is an important relationship between the area of the sail and the weight of the kite. A large boat can carry hundreds of passengers but a small boat will sink if there are as many passengers as the large boat. The same is true for kites. The kite must be light enough to float on the current of air.

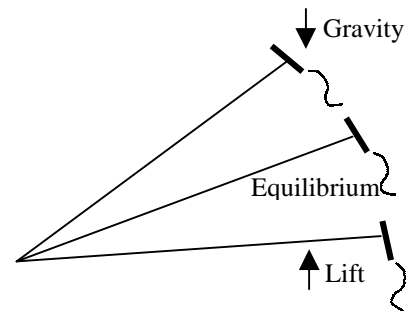

Classroom Demonstration: You can show your class that "gravity is always in effect" by dropping an object. The object will fall toward the nearest massive object, the earth.

Drag

A longer tail will often help to stabilize a kite by adding drag below the kite without adding much weight. The tail will help keep the kite pointed into the wind.

Classroom Demonstration: Fly a kite that requires a tail and successively shorten the tail until the kite becomes unstable.

Dihedral

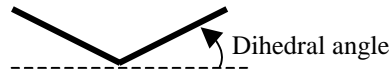

In geometry, an angle formed by two planes is called the "dihedral." On kites, it is the bow or "V" shape of the kite. The typical dihedral angle is about 30 degrees, or 15 degrees on each side. The dihedral gives the kite roll stability. When a kite with a dihedral rolls left or right, the wind exerts greater force on the side flattest to the wind therefore pushing it back into equilibrium. This gives roll stability and yaw stability.

1. Wind exerts equal force on both sides (top view)

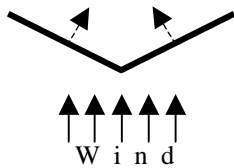

2. One side tilts, giving more pressure on that side

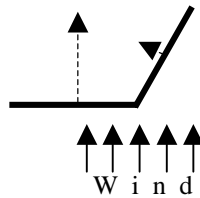

3. Forced back to equilibrium

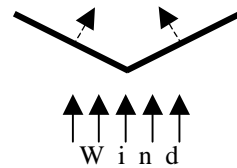

Roll vs. Pitch vs. Yaw

Roll - When a kite twists, flutters, or rolls, it is usually caused by a kite that is not symmetric. Make sure left and right are the same size and that the bridle or tow point are in the center.

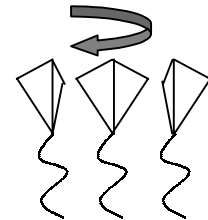

Pitch - The angle that a kite is tilted into the wind is also called the pitch or "angle of attack." This can be adjusted by moving the tow point up or down on the bridle. The lift generated by the kite is related to the pitch and the sail area. In light winds the kite should be adjusted to have a large angle of attack and in strong winds the angle of attack should be reduced.

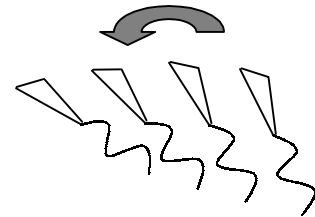

Yaw - If the kite turns or spins left or right, lengthen the tail to add drag or bow the kite to increase the dihedral.

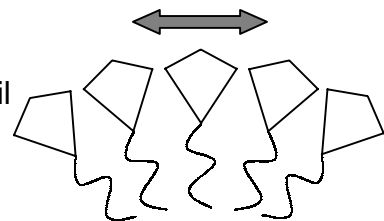

MATHEMATICS

Kites can be used to teach mathematics at every level of education from preschool to graduate school. Here is a sample of activities to try in your classroom:

Altitude

Calculate the altitude of a kite given the length of the line and the angle of elevation.

$$\text{altitude} = \text{string_length} * \cosine(\text{angle_of_elevation})$$

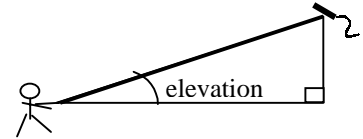

Area

Calculate the area of a kite. This can be easy or difficult based on the shape of the kite. The kite can be divided into triangles or rectangles so their areas can be calculated easier.

$$\text{area} = \text{sum of parts}$$

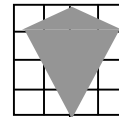

Aspect Ratio

Compare the aspect ratio of different kites, even kites with the same area can have different aspect ratios. An example of this is turning a rectangular kite on its side. The aspect ratio is the comparison of the height to the width of a kite.

$$\text{aspect_ratio} = \text{height} / \text{width}$$

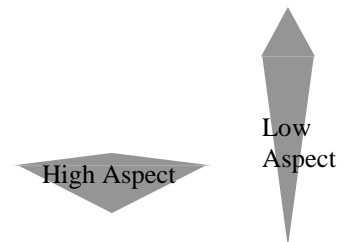

Conversion

Convert measurements from English to Metric or Metric to English.

$$1 \text{ foot} = .3048 \text{ meters}$$

$$1 \text{ inch} = 2.54 \text{ centimeters}$$

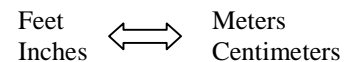

Estimation

Estimate the cost of the kite based on the amount of materials needed. Doubling the size of a kite gives four times the area.

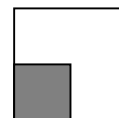

Measurement

Measure the size of the various parts of a kite using English and Metric units.

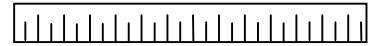

Sail Loading

Sail loading is a ratio of the weight of a kite to the size of the kite (area). This tells us how well the kite will fly in light winds. You may wish to calculate the sail loading for a variety of kites. Calculate the sail loading for a single kite, then add heavy tape such as duct tape. Next, recalculate the said loading and try to fly it.

$$\text{sail_load} = \text{weight} / \text{area}$$

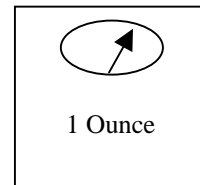

Scaling

Change the size of a kite with all pieces scaling proportionately. Use ratios.
 $\text{width/height} = \text{WIDTH/HEIGHT}$

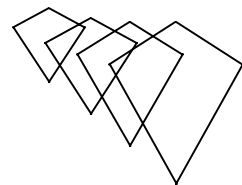

Symmetry

Discuss symmetry and geometry using kites. Most kites are symmetric across the spine of the kite.

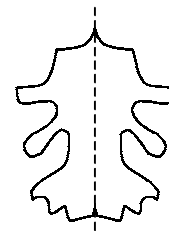

Time and Motion

How much wind moves over your kite if the wind is a steady 12 mph and you walk into the wind at 3 mph? What about walking away from the wind at 3mph?

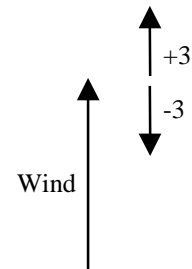

FLYING A KITE

When to fly

If conditions are right, kites can be flown at any time of the year. Observe the wind before trying to fly your kite. Trying to fly without wind, or during periods of heavy, gusty wind conditions will frustrate anyone. Kite flying is fun. You just have to observe a few simple rules. Choose a day to fly kites based on the wind. Do not fix a date and hope the wind will fit your schedule!

Choose the Best Location

The best places to fly are the beach or a park or an open field where there are no trees, roads, power lines, buildings, or obstructions to the wind.

Obstructions block the wind and cause turbulence. In general, the distance you must move away from an obstacle is seven times the height of the obstacle.

Use a Long Launch



Wind Speed

Beaufort #	MPH	Km/H	Knots	Characteristics	Name	Good day?
1	1-3	2-5	1-3	Smoke drifts	Calm	Too little
2	4-7	6-11	4-6	Leaves rustle	Light	Yes
3	8-12	12-19	7-10	Leaves dance	Gentle	Yes
4	13-18	20-29	11-16	Trees toss, dust flies	Moderate	Yes
5	19-24	30-39	17-21	Small trees sway	Fresh	Too much
6	25-31	40-50	22-27	Large branches sway	Strong	Too much

Wind Direction

Ask your class, "how do you know the wind direction?" Possible answers include the observation of: hair, flags, tall grass, leaves on trees, smoke, drop some sand or grass, turn your face, use a weather vane, or your breath in cold weather. Archie Stewart says, "If the wind's in your face, you're in the wrong place!" Always fly with the wind at your back.

Suggestion: Bring a "flight kit" with cellophane tape, scissors, extra sticks, extra string, bandaids, and sunblock.

Suggestion: Arrange a kite parade or compete for highest kite, highest angle of flight, fastest to unspool, most colorful or weirdest.

SAFETY

Fly your kite where it will not cause a hazard to yourself or others. Kites should be flown in an open area, away from people, roads, and obstructions.

Since kites and kite lines can be dangerous, safety should always be your primary concern. Be aware of your environment. If there is ever any question of safety, fly the kite in another location or on another day.

- Never fly your kite near power lines. If your kite becomes tangled in power lines, *leave it there*, notify your utility company of the situation.
- Never fly near cars.
- Never fly near an airport.
- Never fly in stormy weather or when a storm is approaching.
- Never fly over people.
- Avoid kite-eating trees.
- Always keep a safe distance from other fliers.

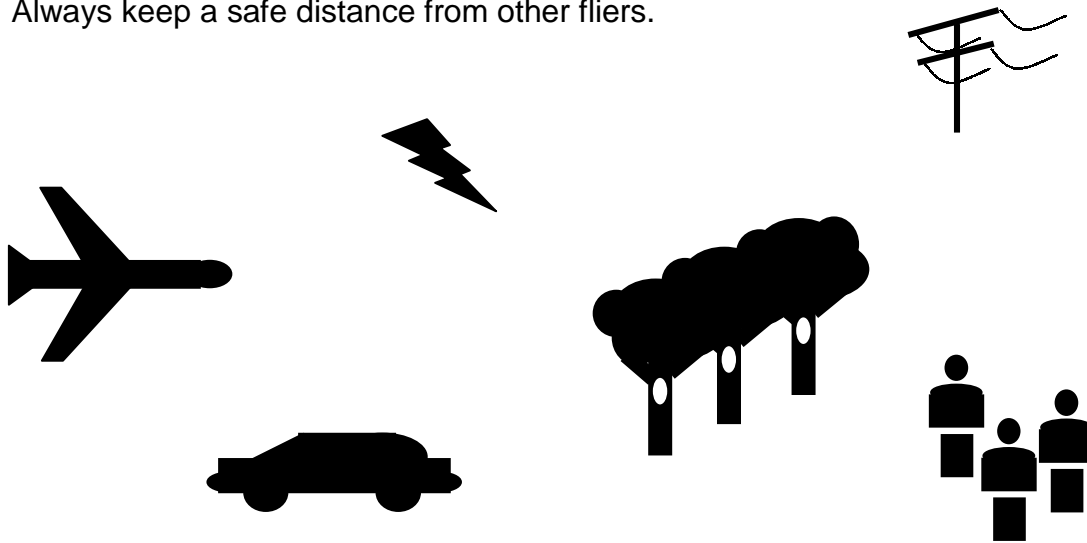

Tip: You can prevent problems by restricting the length of the line that students use. Make it shorter than the distance to the nearest obstacle!

Note: The most frequent injury during kite flying is sunburn. Be sure to protect yourself and your students from the sun with hats, sunglasses, and sunscreen.

Note: The second most frequent injury during kite flying is a cut or burn from the kite line. Do not allow the line to zip through your fingers. Do not use monofilament fishing line. For large kites, protect your hands by wearing leather gloves.

RUNNING A WORKSHOP

Preparation

- Choose a kite to build based on the age and ability of your students
- Practice by building and flying your workshop kite in advance to make sure you understand every step in the process
- Choose a building location that is sheltered from the wind
- Arrange for enough time to build and fly
- Arrange for enough helpers
- Decide if you will build one kite at a time, build them all at once, or use teams
- Buy materials in bulk (see chapter called "Materials")
- Precut materials such as sails, tape, and tails
- Prepare string on spools. Do not use monofilament fishing line which can be dangerous because it is difficult to see and knot and it is not biodegradable
- Bring extra materials including replacements for parts that break
- Do not use needles or razor blades with children
- Avoid toxic markers

Setup

- Arrive early
- Create work areas with all necessary materials, tools, supplies, and chairs
- Work areas should be a comfortable distance apart
- Explain the process to helpers



Build

- All students should be facing you
- If you have time, encourage the students to decorate their kites before construction begins
- Go slowly but keep them interested
- Show each step clearly with diagrams or with your kite as an example
- When showing a step, tell them "Everyone's eyes should be on me"
- Have them write their name on their kite to avoid ownership problems

Clean Up

- Make sure they clean the work area before leaving
- Warn students of the hazards of flying
- Inform students of wind direction and launching procedures
- Tell them to "have fun flying your kites!"

Suggestion: Students will want to fly the kites right away so plan enough time and choose a proper location in advance.

WORKSHOP KITES TO BUILD AND FLY

<u>Page</u>	<u>Kite Plan</u>
28	Sled Kite
29	Eddy Kite
30	Bumble Bee Kite
31	Tadpole Kite
32	Cub Kite
33	Dingbat Kite
34	Ladybug Kite
35	Picnic Plate Kite
36	Grocery Sack Kite
37	Fighter Kite
38	S.E. Asian Children's Kite
39	Japanese Children's Kite
40	Hexagon Kite
41	Box Kite



Sled Kite Plan (Allison)

- WIND:** Light to Moderate (4mph to 18mph)
LINE: Crochet or button hole thread
SAIL: (1) 24" x 30" plastic trash bag (kitchen size)
SPARS: (2) 16" x 1/8" wooden dowels
 ALTERNATIVE: Use match-stick bamboo
BRIDLE: 48" flying line
TAIL: Optional. Use bag scraps.
TAPE: Cellophane

METHOD:

1. Draw half of the kite on edge of plastic bag and cut out. (a)
2. Tape spars to sail. (b)
4. Attach 48" bridle to sail. (b)
5. Find center of bridle by placing keels together and tie a loop. (c)
6. Tie flying line to loop. (c)
7. OPTIONAL: Roll remaining bag and cut 1-1/2" wide tails. Tape to bottom at each spar. (d)

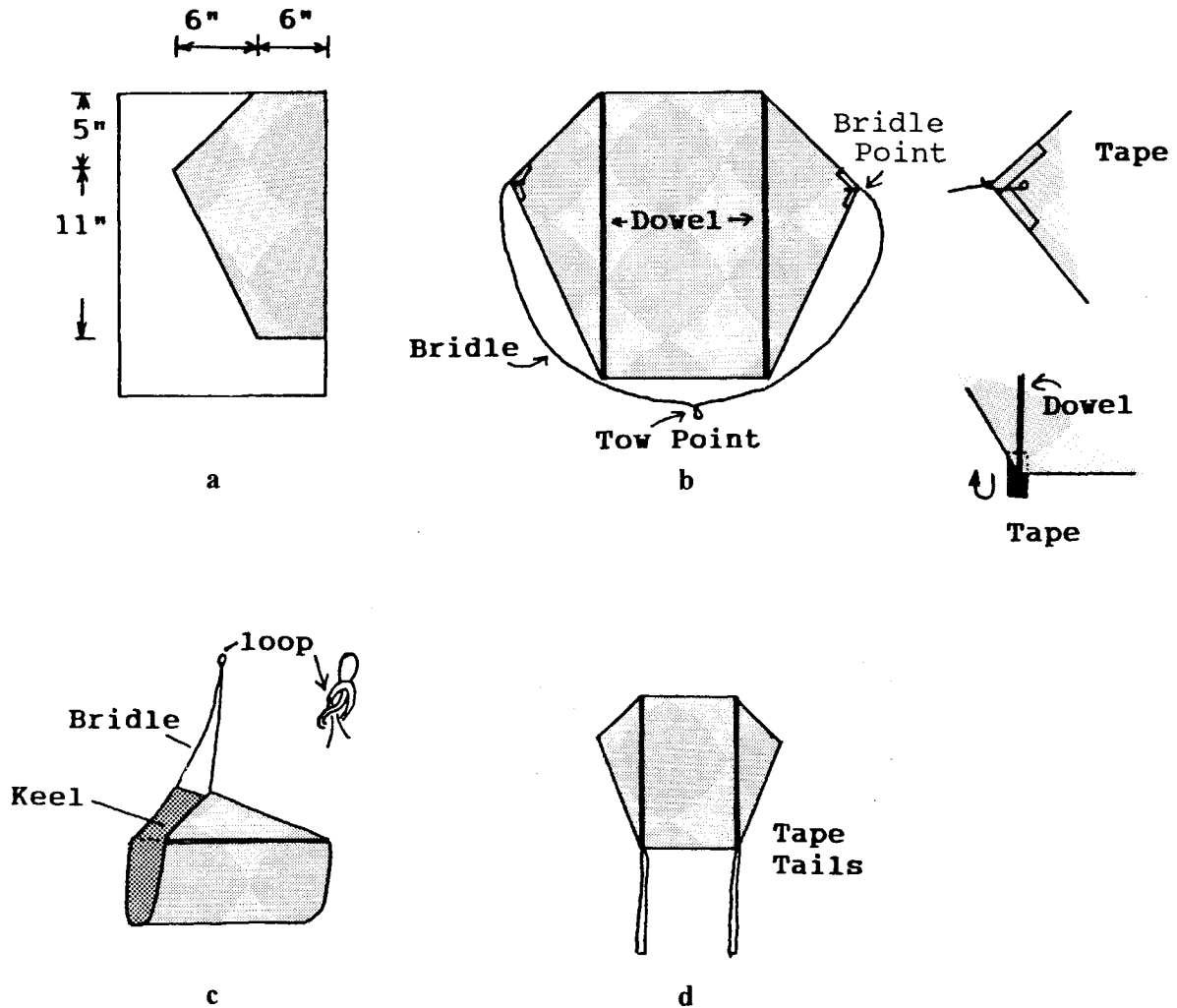

Eddy Kite Plan

- WIND:** Light to Moderate (4mph to 18mph)
LINE: Cotton string on spools
SAIL: (1) Tall plastic kitchen garbage bag, 13 gallons
SPARS: (2) 24" x 1/8" wooden dowels
BRIDLE: 48" flying line
TAIL: Surveyor's flagging tape or 1" wide strips of plastic
TAPE: Strapping tape

METHOD:

Preparation

1. For each kite you will have wooden dowels for a 24" spine and a 24" spreader.
2. Soak the spreaders in water overnight. Place the soaked dowels on a drying rack bent to form a dihedral offset of 3" at the center. Let the dowels dry for at least 24 hours.
3. Precut sails and center holes.
4. Precut tape to 3" lengths, with 8 pieces per kite.
5. Precut tails to 7' lengths.

Setup for each student

6. Lay out the sail: opened and flat
7. One spine and spreader
8. Eight pieces of tape 3" long
9. One spool of string
10. 7' of tail

Steps for students

1. Attach spine with tape by folding the tape over equally on front and back. (a)
2. Attach spreader with tape in the same manner. The sticks should cross at the hole in the sail. (b)
3. Put 4 pieces of tape on the sticks near the center as reinforcement. (b)
4. Tie the tail to the bottom of the spine. (c)
5. Attach line through the hole in the front where the sticks cross. (c)

(a) Tape the spreader down

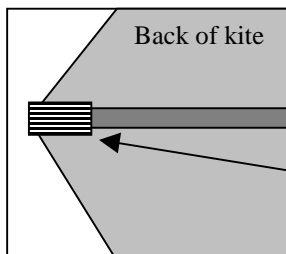

(b) Reinforce center with tape

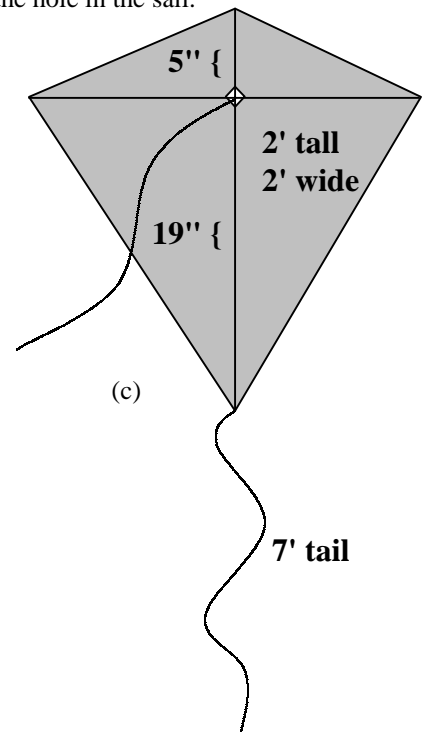
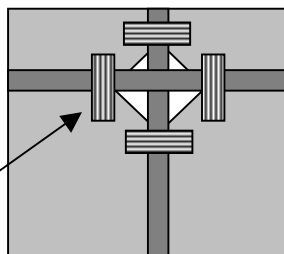

Bumble Bee Kite Plan (Schaeffer)

WIND: Light to Gentle (4mph to 10mph)
 LINE: Sewing Thread
 SAIL: (1) 8-1/2" x 11 Bond Paper
 SPARS: None
 BRIDLE: Single tow point
 TAIL: None
 TAPE: Use a stapler instead of tape

METHOD:

1. Fold paper in half.
2. Mark points A and B.
3. Pull the two top corners to point A and staple, but DO NOT FOLD FLAT.
4. Punch a hole at B.
5. Attach flying line.

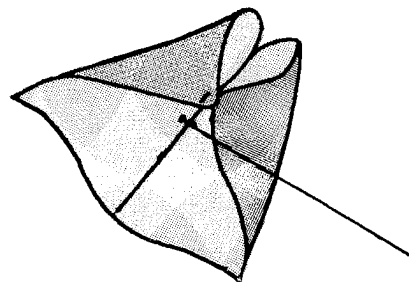
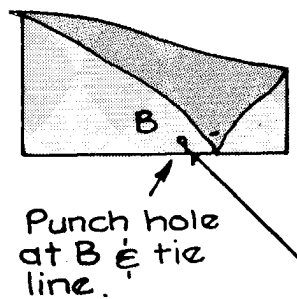
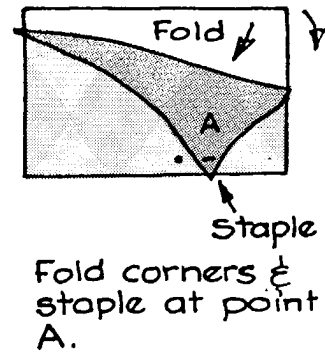
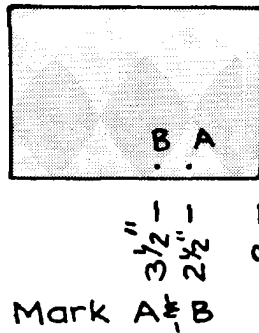
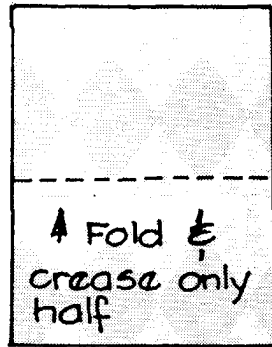

Tadpole Kite Plan (Hosking)

- WIND: Light to Gentle (4mph to 10mph)
LINE: Sewing Thread
SAIL: (1) 8-1/2" x 11" Bond Paper
SPARS: None
BRIDLE: 36" flying line
TAIL: (1) 1-1/4" x 6' x 2 mil. plastic trash bag strips
or Surveyor's flagging tape
(1) 12" of flying line to be used as the tail line
TAPE: Cellophane

METHOD:

1. Fold paper in half lengthwise. (a)
2. Fold flaps in half in the opposite direction. (b)
3. Fold top and bottom corners back and cut off flaps. Repeat on the other side. (c)
4. Tape bridle line to keels (1) and (2). Tie a loop in the center of bridle for the tow point.
5. Cut three 1-1/4" wide strips and tape together to create the 6 foot tails.
6. Tape tail line to tail and to kite at point (3).

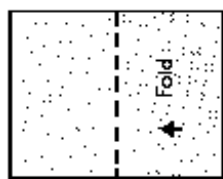

(a)



(b)



(c)

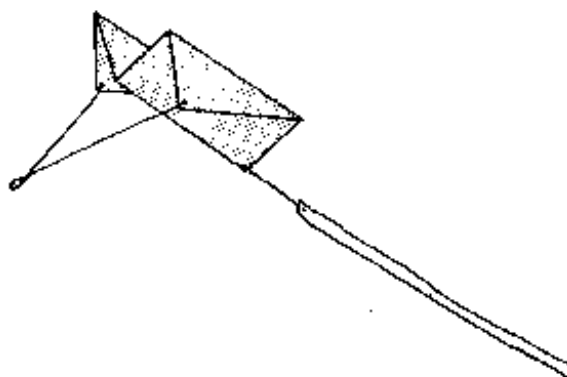
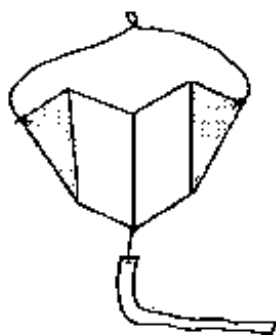
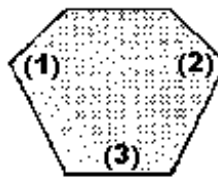

Cub Plan (Hosking)

- WIND:** Light to Gentle (4mph to 10mph)
LINE: Sewing Thread
SAIL: (1) 8-1/2" x 11" Bond Paper
SPARS: (1) drinking straw
 ALTERNATIVE: use 1/8" dowel or match-stick bamboo
BRIDLE: Single tow point
TAIL: (3) 1-1/4" x 6' x 2 mil plastic trash bag strips
TAPE: Cellophane

METHOD:

1. Fold paper in half lengthwise. (a)
2. Punch a hole 3-1/4" from the front, along the keel. (b)
3. Fold along a line 1-1/2" from the crease, in both directions. (c)
4. Tape the drinking straw 3/4" from the front and bend up corners. (d)
5. Tie the tails together at one end and tape to back of kite. (d)
6. Attach the flying line to the tow point. (e)

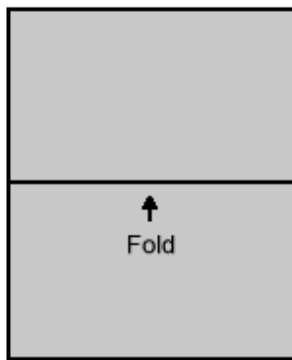

(a)

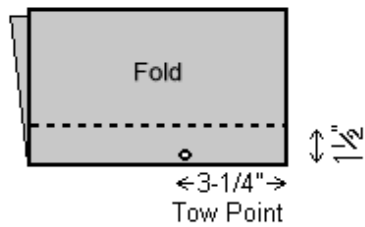

(b)



(c)

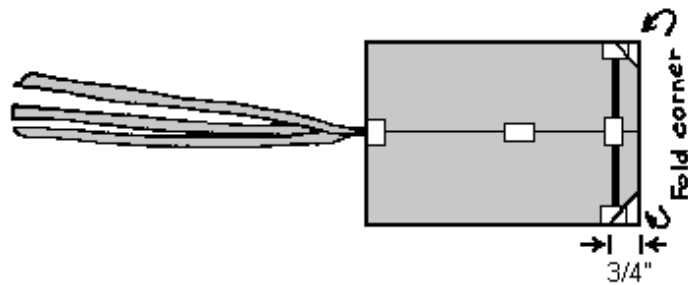

(d)

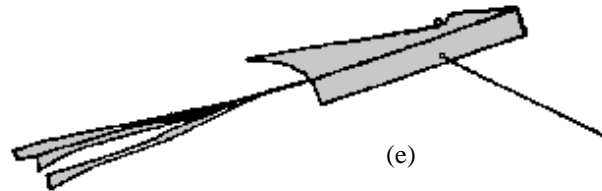

(e)

Dingbat Kite Plan (Zachary)

- WIND: Light to Gentle (4mph to 10mph)
LINE: Sewing Thread
SAIL: (1) 8-1/2" x 11" Bond Paper
SPARS: None
BRIDLE: (1) 18" flying line
TAIL: (2) 1-1/4" x 6' x 2 mil. plastic trash bag strips
(1) 12" of flying line to be used as the tail line
TAPE: None

METHOD:

1. Fold to make a square. (a)
2. Cut off overlap. (b)
3. Fold along folds 2, 3, 4, 5. (b)
4. Punch holes at A, B, and C. (c)
5. Tie 18" bridle line ends at A and B, and tie a small loop in center of bridle. (c)
6. Tie 12" tail line to C and to tail. (c)

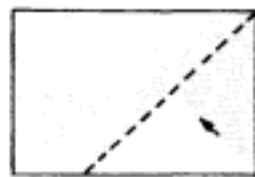

(a)

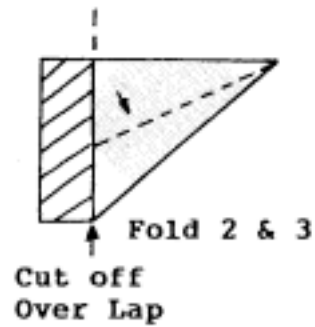

(b)

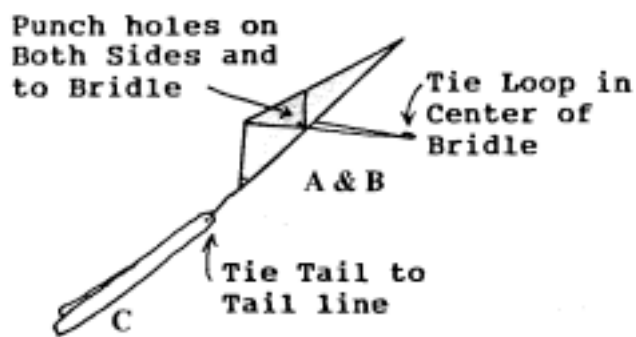
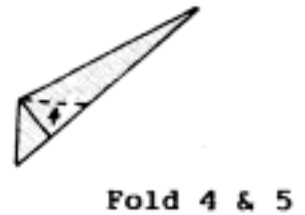

(c)

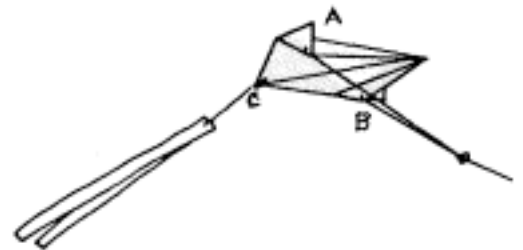

Ladybug Kite Plan (Japan)

WIND: Light to Gentle (4mph to 10mph)
LINE: Button hole thread
SAIL: (1) 10" x 12" tissue paper
SPARS: (1) 12" match-stick bamboo (spine)
(1) 11" match-stick bamboo (spreader)
(2) 3" bamboo slivers (optional-supports)
BRIDLE: None
TAIL: (3) 3/4" x 7' crepe paper strips
TAPE: Cellophane

METHOD:

1. Fold paper in half, widthwise. (a)
2. Divide the paper into thirds by folding lengthwise at 4". (b)
3. Draw kite outline and cut out. Cut a small "v" at tow point. (c)
4. Tape spine, spreader, and optional supports to sail. (d)
5. Tape tail to sail. Bow the spreader 2 inches. (d)
6. Tie flying line to kite at tow point. (e)

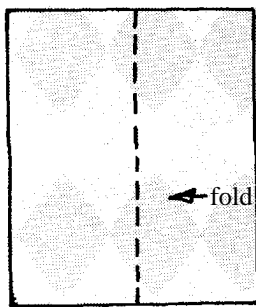

a



b

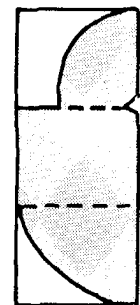

Cut "v" here

c

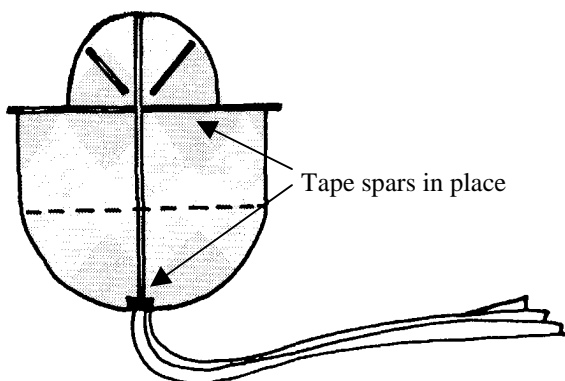

Tape spars in place

d

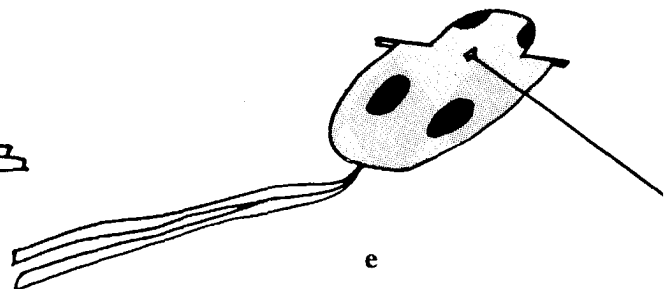

e

Picnic Plate Kite Plan

WIND: Light to Moderate (4mph to 16mph)

LINE: Button hole thread

SAIL: Use a 9" Styrofoam Plate

NOTE: Not all plates are the same shape or size.

It is best to test the kite before giving a class.

SPARS: None

BRIDLE: None

TAIL: 18' x 2" plastic strips (trash bag) or surveyor's flagging tape

TAPE: Cellophane

METHOD:

1. Turn plate upside down. Draw a line down the center of the plate.
NOTE: Use a folded sheet of 8-1/2" x 11" paper to find the plate's center. (a)
2. Punch a hole 3-1/2" from the top, along the line.
3. Push one end of flying line through the hole in the front of the plate and tape to back. (b)
4. Tape tail to bottom of kite, on the drawn line. (c)

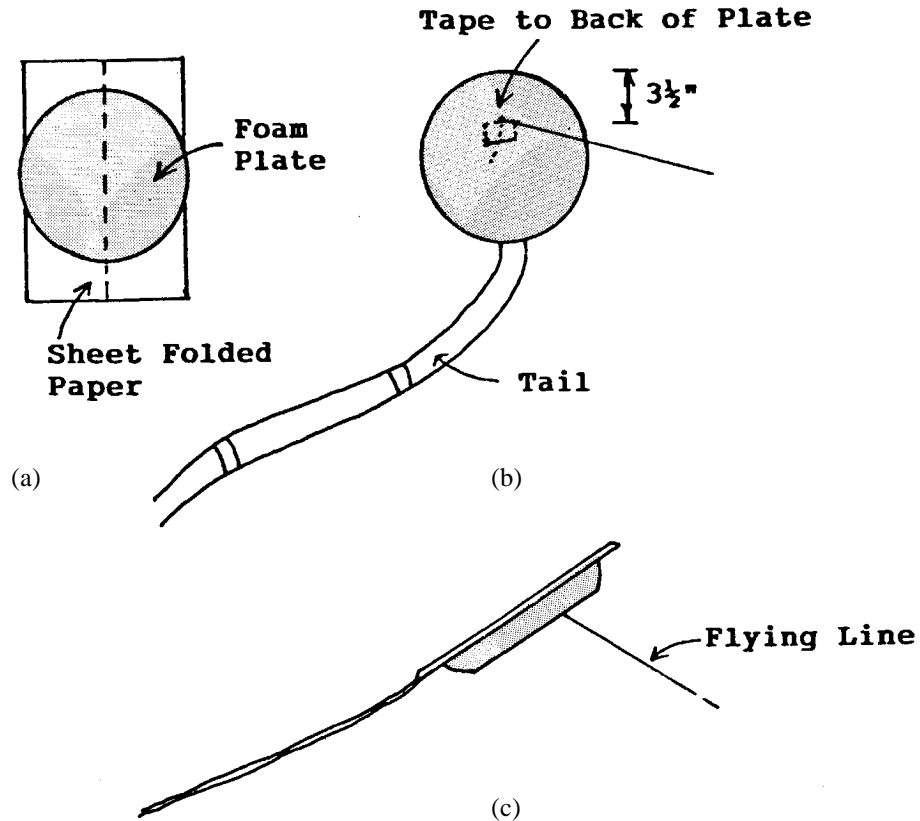

Grocery Sack Kite Plan

WIND: Moderate to Strong (4mph to 31mph)
LINE: Crochet or Button hole thread
SAIL: (1) Brown paper grocery sack
SPARS: (1) 12" x 1/8" dowel or bamboo skewer
BRIDLE: None
TAIL: None
TAPE: Cellophane

METHOD:

1. Cut along three (out of four) edges of the bottom of the sack. (a) Fold bottom (flap) inside sack.
2. Find the center of flap and punch a hole 1-1/2" from the edge, on center. (b)
3. Pass the flying line through the hole, into the bag. Tie it to the dowel. (c)
4. Tape dowel to bag 1-1/2" from the edge. (c)

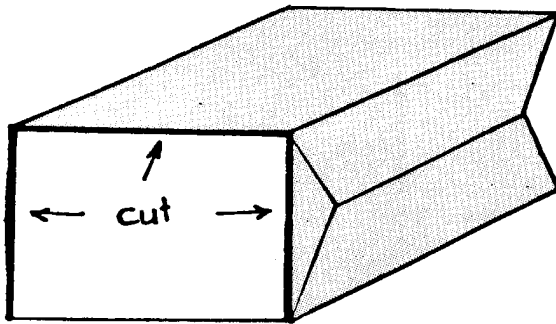

(a)

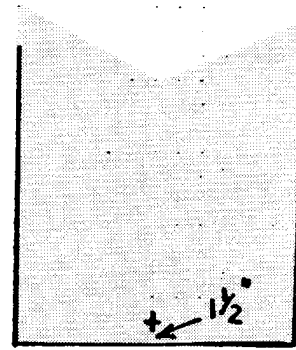

(b) Punch hole

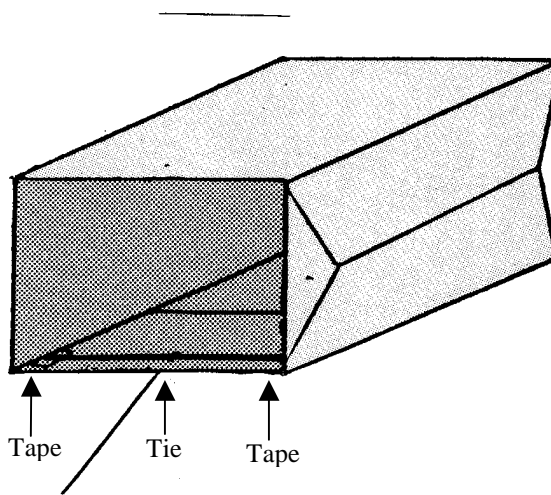

(c)

Fighter Kite Plan

- WIND:** Light to Moderate (4mph to 18mph)
LINE: Button hole thread
SAIL: (1) 15" square plastic sheet (e.g. trash bag)
SPARS: (1) 21" x 1/8" dowel or match-stick bamboo (bow)
 (1) 24 x 1/8" dowel or match-stick bamboo (spine)
BRIDLE: (1) 22" flying line
TAIL: (2) 15" plastic strips
TAPE: Cellophane

Note: The fighter kite is an intentionally unstable kite which requires practice to fly. Pulling on the line causes it to move in the direction it is pointed; giving it slack makes it turn or spin. Alternating tension and slack enables the flier to steer the kite in the sky. A long tail may be added to the base of the spine for stability, and then shortened as the flier learns to control the kite.

METHOD:

1. Tape along leading edge. Fold sail in half. Fold and snip 1/8" at corners for bridle points.
2. Reinforce spar. Tape spine and spar to sail.
3. Attach bridle. To find tow point hold the bridle with kite flat. Tie a loop 1/2" above this point.
4. Tape plastic strips to sides.

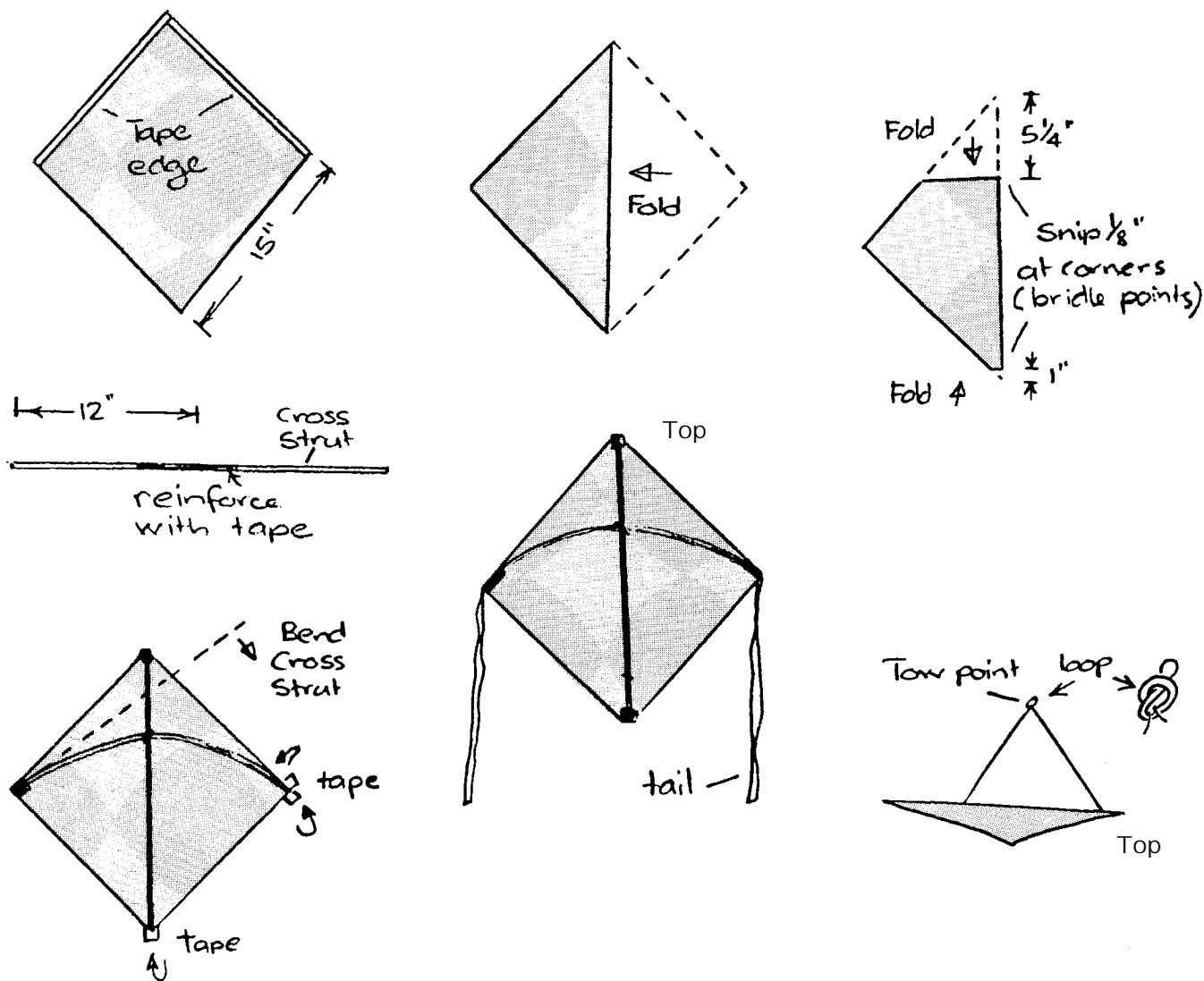

S.E. Asian Children's Kite Plan - a.k.a. Vietnamese Children's Kite

- WIND:** Light to Moderate (4mph to 18mph)
LINE: Button hole thread
SAIL: (1) 12" square newspaper
SPARS: (1) 15" match-stick bamboo (spine)
 (1) 21-1/2" match-stick bamboo (bow)
BRIDLE: 29" of flying line
TAIL: (4) 1" x 7' crepe paper strips
TAPE/GLUE: White glue
PATCHES: Scrap paper

METHOD:

1. Fold sail in half and cut small holes at bridle points.
2. Unfold and mark the flaps. Fold flaps and crease.
3. Glue spine to kite.
4. Glue one side of bow to kite. Carefully bend the bow and glue the other side to the kite. You may have to hold the bow for a short time while the glue takes hold. Adjust the bow's symmetry with paper patches.
5. Glue tail to kite and attach bridle.

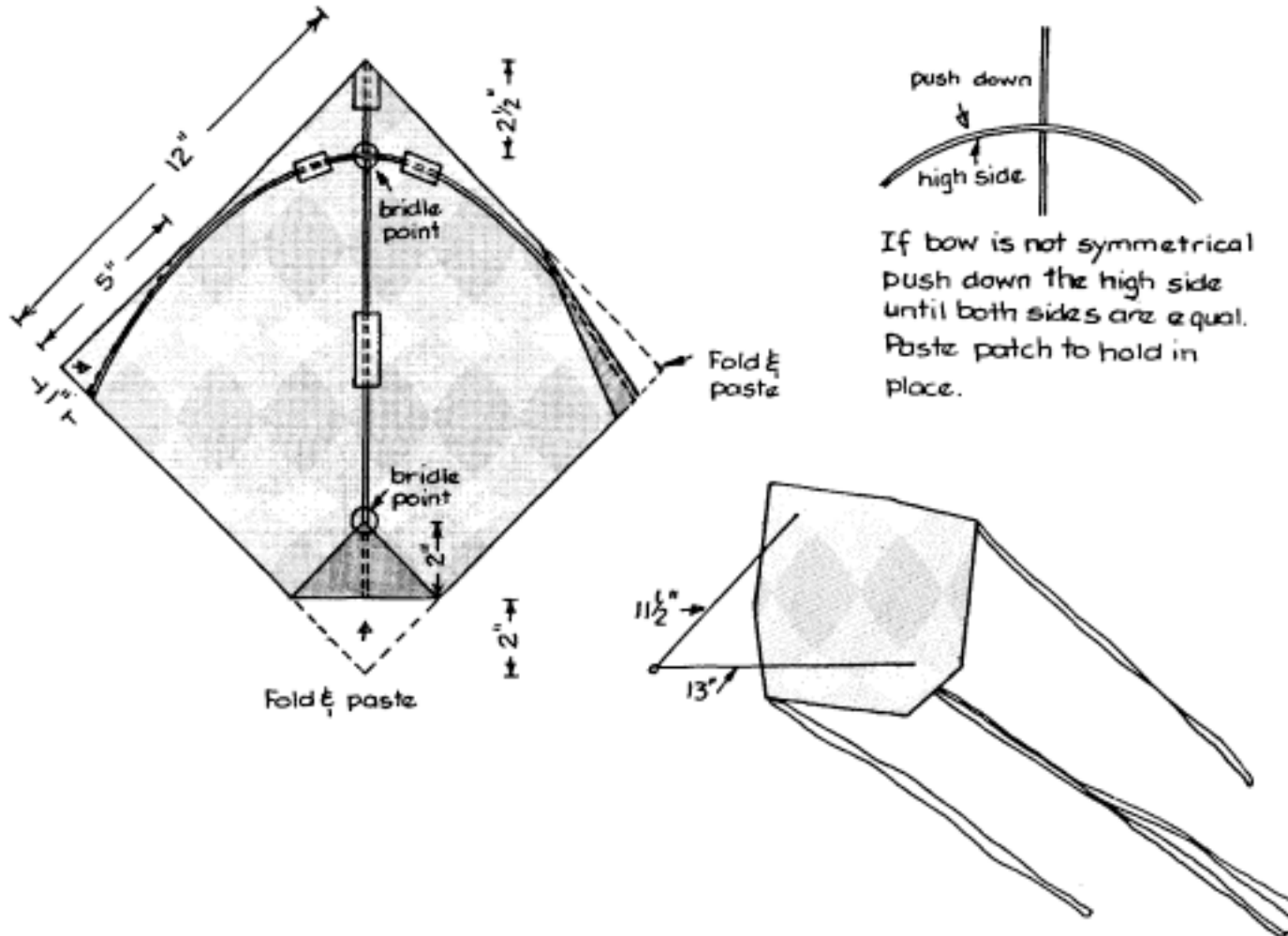

Japanese Children's Kite Plan

- WIND:** Light to Moderate (4mph to 18mph)
LINE: Button hole thread
SAIL: (1) 12" x 16-1/2" lightweight wrapping or tissue paper
(7) 1" x 1" reinforcing patches
SPARS: (1) 16" match-stick bamboo (spine)
(1) 13" match-stick bamboo (spreader)
(1) 16" flying line (spreader bow line)
(2) 20-1/2" match-stick bamboo (cross spars)
BRIDLE: (1) 35" flying line (upper leg)
(1) 18" flying line (lower leg)
TAIL: (4) 3/4" x 7' crepe paper strips
TAPE/GLUE: White glue

METHOD:

1. Fold sail in half widthwise to find center.
2. Snip a small hole for the center bridle point. Unfold sail.
3. Place the spreader at the top edge of the kite. It should extend 1/2" on either side of the sail. Fold 1/2" flap and glue spreader to sail under flap.
4. Glue spine and cross spars to sail.
5. Glue tails onto kite.
6. When the glue on the spreader is dry, attach a bow line to the ends and bow the spreader 1-1/2" deep.
7. Attach reinforcing patches as shown.
8. Attach bridle as shown. Circles indicate bridle attachment points.

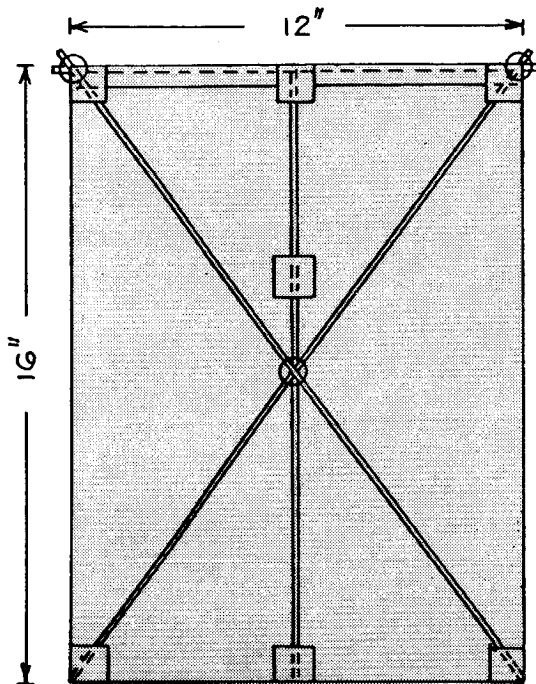

Fold & glue
1/2" over lap

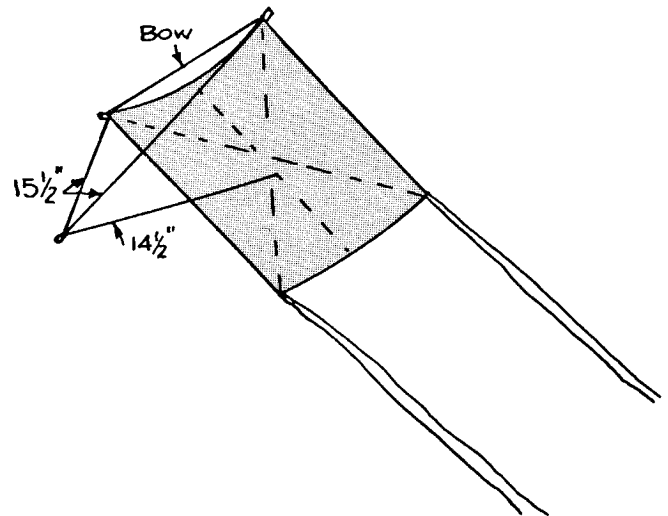

Hexagon Kite Plan

- WIND:** Gentle to Moderate (8mph to 18mph)
LINE: 30 lb. test
SAIL: (3) 20" x 24" sheets tissue paper
SPARS: (3) 36" x 3/16" dowels
 (1) 110" framing line
 (1) 37" bow line
BRIDLE: (1) 66" flying line (two upper legs)
 (1) 32" flying line (lower leg)
TAIL: (4) 1" x 15' surveyor's flagging tape or crepe paper
TAPE/GLUE: White glue

METHOD:

1. Mark center of spars and saw slits in the ends of the dowels. (a)
2. Cross spars and tie together with string or a rubber band. Tie framing line around kite. (b)
3. Cut out sail pieces allowing for glue flap all round. (c)
4. Glue sail pieces to frame in sequence. (d)
5. Attach bow line to horizontal spar. (e)
6. Tie bridle to spars by threading line with a needle, through kite cover. (f)
7. Tie tail to kite. (f)

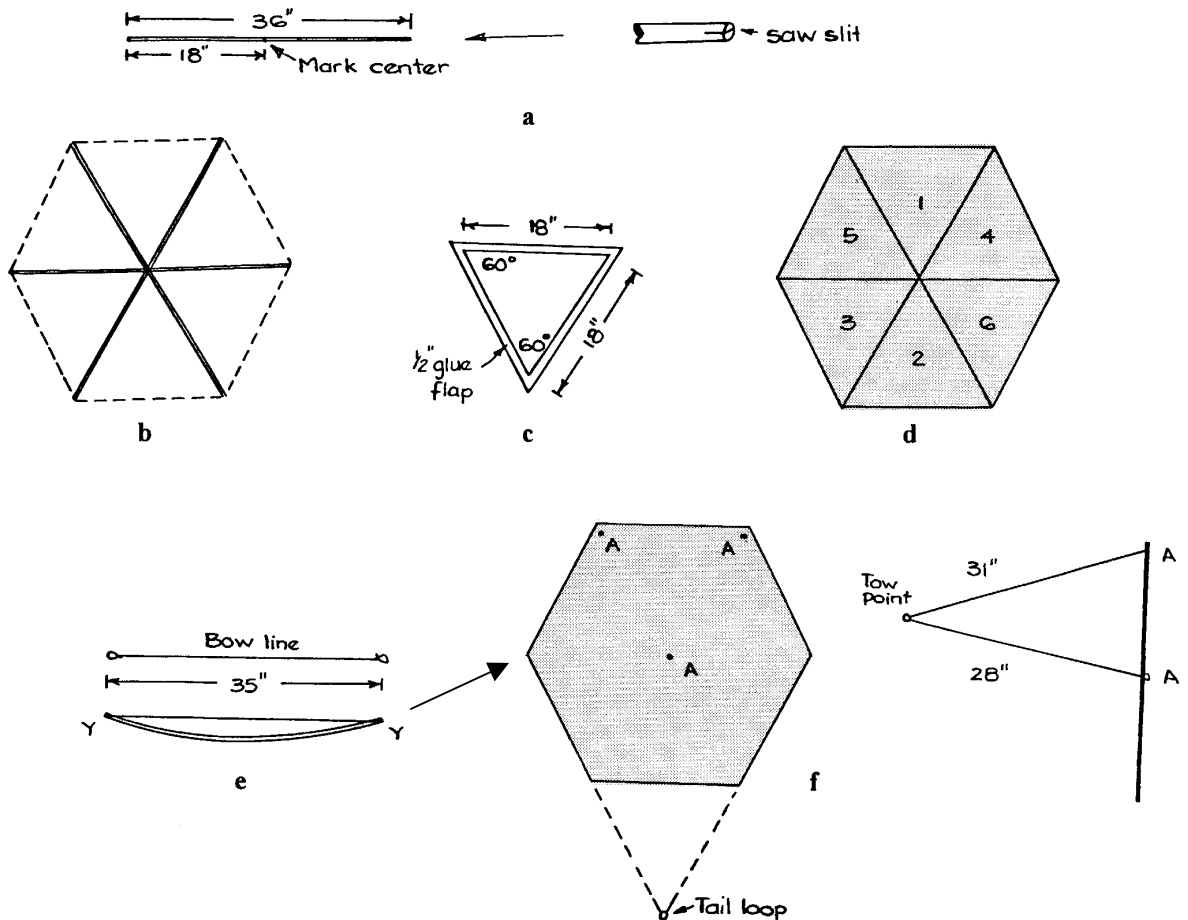

Box Kite Plan

- WIND:** Moderate to Strong (13mph to 31mph)
LINE: 20 lb. test
SAIL: (1) 24" x 30" plastic trash bag (kitchen size)
SPARS: (4) 24" x 3/16" wooden dowels (side spars)
 (4) 16-1/2" x 3/16" wooden dowels
 (8) 1-1/2" x 3/16" inner diameter soft plastic tubing for connectors
BRIDLE: Single tow point
TAIL: None
TAPE: Cellophane

METHOD:

1. Cut off closed bottom of bag. (a)
2. Fold bag in half lengthwise. Mark or snip each corner. (b)
3. Fold bag in half. (c)
4. Fold bag again and cut off corner 4" x 4" at closed end. (c & d)
5. Fold tubing and cut off one corner on each piece of tubing. (f) Slide tubing onto spars. (g)
6. Tape side spars to inside of kite at comers. (h)
7. Fit cross spars into tubing on side spars. (i & j)
8. Tie flying line to tow point 4" from top of kite. (k)

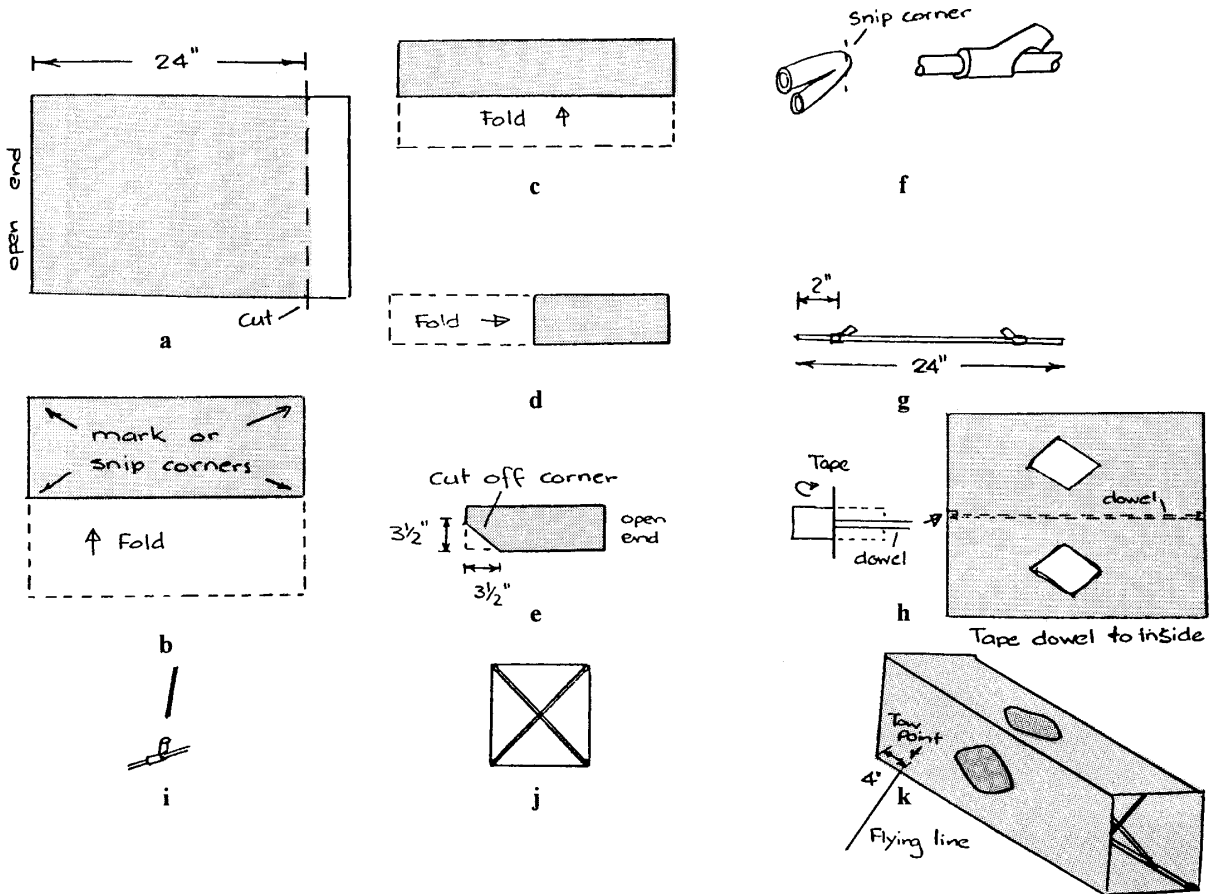

APPENDICES

BIBLIOGRAPHY

- BELSKY, Nancy Ann, BUILDING KITES, 1995, Palo Alto, CA, Dale Seymour Publications
 - BRUMMITT, Wyatt, KITES, 1971, New York, Golden Press
 - DAVISON, Glenn, KITES IN THE CLASSROOM, 2002, Walla Walla, WA, American Kitefliers Association
 - GREGER, Margaret, KITES FOR EVERYONE, 1984, Richland, WA, Self Published
 - HART, Clive, KITES: AN HISTORICAL SURVEY, 1982, Mt Vernon, NY, Paul Appel
 - HIROI, Tsutomu, KITES, SCULPTURING THE SKY, 1978, New York, Pantheon Books
 - HOSKING, Wayne, KITEWORKS 1: PAPER FOLD KITES, 1986, Houston, TX, Self Published
 - HOSKING, Wayne, FLIGHTS OF IMAGINATION, 1987, Washington, DC, National Science Teachers Association
 - HOSKING, Wayne, STUDENTS' KITE PROJECT GUIDE, 1987, Houston, TX, Gayla Industries
 - HOSKING, Wayne, KITES OF MALAYSIA, 1990, Malaysia, Malaysian Airline System
 - ITO and KAMURA, KITES, 1979, Tokyo, Japan
 - MOULTON, Ron and LLOYD, Pat, KITES: A PRACTICAL HANDBOOK, 1992, London, Argus Books
 - MOUVIER, Jean-Paul, KITES, 1974, Paris, Collins
 - PELHAM, David, KITES, 1976, New York, Penguin
 - TOY, Leland, KITE PATTERNS, 1984, San Francisco, CA, Sky High Press
- Reference book. Kite book for classroom use.

Additional references from <http://www.kitetrade.org/NationalKiteMonth/dg/resour.html>

- Dolan, Edward. The Complete Beginner's Guide to Making and Flying Kites. 145p. Doubleday and Co. 1977
- Eden, Maxwell. Kiteworks. 416p. Sterling Publishing Co. 1990
- Gallot, Philippe. Fighter Kites: Twenty Original Designs to Make and Fly. 96p. St Martin's Press. 1990
- Gomberg, David. Stunt Kites. 89p. Sixth Edition, GKPI. 1996
- Gomberg, David. The Fighter Kite Book. 75p., GKPI. 1992
- Gomberg, David. Sport Kite Magic! 123p., GKPI. 1996
- Greger, Margaret. More Kites For Everyone. 59p. M Greger. 1990
- Hunt, Leslie. Twenty-five Kites That Fly. Dover. 1971
- Pelham, David. The Penguin Book of Kites. 224p. Viking Penguin. 1976
- Rowlands, Jim. The Big Book of Kites. 132p. St Martin's Press. 1988
- Rowlands, Jim. One-Hour Kites. 95p. St Martin's Press. 1989
- Streeter, Tal. The Art of The Japanese Kite. 181 p. Weatherhill, Inc. 1985
- Thiebault, Andre. Kites and Other Wind Machines. 96p. Sterling Publishing Co. 1982
- Wiley, Jack. The Kite Building and Kite Flying Handbook, with 42 kite plans. 278p. TAB Books. 1984
- Yolen, Jane. World On A String, The Story of Kites. 143p. The World Publishing Co. 1968
- Yolen, Will. The Complete Book of Kites and Kite Flying. 256p. Simon and Schuster. 1976

GLOSSARY

AERODYNAMICS: the study of the motion of the air and its physical effects on bodies moving through it.

AIRCRAFT: any flying machine including airplanes, airships, gliders, kites, or helicopters.

AIRFOIL: a special shape that converts moving air to lift (e.g., flowforms, parafoils, or Flexifoil kites).

ANGLE OF ATTACK: the angle or pitch of the kite with respect to the wind.

AXES OF ROTATION: the three imaginary lines that pass through a kite's center of gravity at right angles to each other. All movements of a kite can be defined in these terms. (See PITCH, ROLL, YAW).

BRIDLE: a bridle connects the flying line to the kite, at the TOW POINT, and sets the angle of the kite to the wind called the ANGLE OF ATTACK. A bridle can have two or more legs. Some kites have a single tow point and no bridle.

CELL: an enclosed area that air flows through. A box kite is a single cell kite. A snowflake is a multi-cell kite.

CHORD: an imaginary line joining the trailing and leading edges of an airfoil section.

DIHEDRAL ANGLE: the bow or "V" shape of the kite.

DRAG: the total air resistance during flight. Tails are usually added to increase drag. A tail with a rough surface provides more drag.

FITTINGS: the connectors that join spars together.

FRAME: the combination of the spars and spine. Not all kites have a rigid frame (e.g., a parafoil kite).

GRAVITY (WEIGHT): the downward pull on a kite.

KEEL: a solid bridle (see BRIDLE) that is made of sail material. This acts like a rudder to add stability.

LEADING EDGE: the forward edge of a kite as it moves forward.

LIFT: the upward force acting against a kite as the result of it deflecting the wind. The force of lift opposes the force of gravity.

LINE: the connection between the kite and the anchor. Also called string or flying line.

PITCH: to rotate about the lateral axis - to tip up or down.

ROLL: to rotate about the vertical axis - to rock sideways.

SAIL: the kite covering, usually fabric or paper.

SAIL LOADING: the ratio of the weight of the kite to the size of the kite (area).

SPARS: sticks that give shape or structure to kites. Spine and spreader are specific names for spars.

SPINE: the central back bone or vertical spar of a kite.

SPREADER: a spar that opens the kite left and right.

STABILITY: the ability to return to a state of equilibrium or normal flight path after being deflected.

STALL: occurs when a kite loses forward speed and the kite becomes stationary in the air.

TAIL: attaches to the trailing edge of a kite to add stability by creating drag (not by adding weight).

TOW POINT: connection point where the line attaches to the bridle.

TRAILING EDGE: the rear edge of an airfoil as it moves forward.

TRAIN or STACK: a series of kites flown on a common line or lines.

VENT: is an opening for the passage of wind that adds stability.

WINDER (REEL): holds the flying line.

YAW: to rotate about the axis of the flying line - to turn to the right or left.



Internet Resources

The American Kitefliers Association (AKA)	http://www.aka.kite.org/
Sign up for periodic Newsletters with useful and interesting info about kiting and the AKA.	http://www.aka.kite.org/ and click on "Table of Contents" then "Become an E-Affiliate." Publication is free - you don't have to be a member. It's designed for students.
Kites in the classroom	http://www.aka.org.au/kites_in_the_classroom/
Kites as an educational tool	http://www.gombergkites.com/nkm/index.html
Kites, kids, and education	http://kckiteclub.org/DaveEllis/TOC.htm
Kite lesson planning	http://www.education-world.com/a_lesson/lesson056.shtml
The names of the parts of a kite	http://www.grc.nasa.gov/WWW/K-12/airplane/kitepart.html
Forces acting on a kite (NASA)	http://www.grc.nasa.gov/WWW/K-12/airplane/kitefor.html
Why does a kite fly?	http://www.gombergkites.com/nkm/why.html
What makes a kite fly?	http://www.aka.org.au/kites_in_the_classroom/student.htm
Kites, a brief history	http://www.aka.org.au/kites_in_the_classroom/history.htm
Kite history and photo gallery	http://fly.to/megsworld
Plans that are easy for kids to make	http://www.aka.org.au/kites_in_the_classroom/plans.htm
The word "kite" in other languages	http://www.kites.org/fredl/kiteword.htm or http://www.gombergkites.com/nkm/words.html
Kite safety	http://www.gombergkites.com/nkm/safety.html
How to fly a kite	http://www.gombergkites.com/howgen.html
Wind in the atmosphere	http://wings.avkids.com/Book/Atmosphere/instructor/wind-01.html
The principles of aeronautics	http://wings.avkids.com/Book/instructor.html
Kite songs and songs with the word "kite" in the lyrics	http://www.kites.org/fredl/kitesong.htm
Kite games	http://www.gombergkites.com/nkm/rec2.html
Kite search engine	http://www.kitez.com/
National Kite Month (every April)	http://www.nationalkitemonth.org/
The Drachen Foundation, a non-profit educational corporation	http://www.drachen.org/
Kite Stores	http://www.gombergkites.com/dir.html
How to run a workshop	http://www.gombergkites.com/nkm/work.html
Geography - Kites from around the world	http://www.gombergkites.com/nkm/samples.html
Bibliography	http://www.aka.org.au/kites_in_the_classroom/biblio.htm

Kite Trouble Shooting

A tail, a bridle, and the location of the tow point will affect the stability of a kite. Be careful with your construction and repairs because small mistakes can make a big difference in how well your kite flies. One easy solution to many problems is to add a longer tail. Depending on the style of kite, you may need a tail that's as much as seven times the length of your kite. The solutions below are for single-line kites.

Problem: The kite won't fly.

Solution:

(a) Check the bridle:

- Are the bridles on the front and the sticks on the back?
- Is the bridle in the center of the kite?
- Is the bridle exactly equal on left and right?
- Does the bridle slide up and down? It should not.

(b) Check the sail:

- Are there any holes or is the sail torn?
 - Is the sail properly attached to the frame?
 - Is the left side the same size as the right side?
- (You can repair these problems with cellophane tape.)

(c) Check the frame:

- Are there bent or broken sticks?
- Do the sticks flex equally on the left and right?

(d) Check the tail:

- Are the tails centered at the bottom of the kite?
- Are the tails equally placed on the sides?

Problem: Your kite spins in circles, snakes from side to side, or flies to one side.

Solution: The kite may be off balance. To correct the problem:

- (a) hold the kite at the tow point, does one side dip down? If it does, correct the balance by adding tape to the lighter side until they are equal
- (b) Move the tow point toward the bottom of the kite.
- (c) Add tails.

Problem: Your kite has a flapping or pitching motion.

Solution: This indicates the kite has a weak frame, an inadequate bridle, or a soft spine that can be distorted by the wind. Add one or more bridle legs or use a thicker spine or spreader.

Problem: Your kite rolls so that one wing lifts and the other is lowered.

Solution: Kites tend to dip to one side to release wind so you can:

- (a) Move the tow point toward the top of the kite.
- (b) Add longer or additional tails to the kite.
- (c) Bow the spreader to create more dihedral.

OTHER AKA PUBLICATIONS

The following publications are available from the American Kitefliers Association, P.O. Box 1614, Walla Walla, WA 99362, USA. Payment must be made by US check, money order, or credit card. Bulk discounts are available.

Kiting Magazine

Kiting The Journal of the American Kitefliers Association includes a kite events calendar, kite plans, local club activities, committee and policy reports, a list of Member Merchants, and more. *Kiting* magazine is mailed to each member of the American Kitefliers Association and is just one of the benefits of membership.

Rule Books

The AKA produces rule books for kite competitions:

The International Sport Kite Competition Rules are used for events focusing on multi-line maneuverable kites. Competitions include precision and ballet for individuals, pairs, and teams.

The AKA Indoor Individual Ballet Competition Rules are available for viewing over the web and in Adobe Acrobat format. A sample score sheet is included and the score sheet is available alone.

Rules and Guidelines for Kitemakers' Competitions details categories, judging criteria, and the scoring process for AKA contests evaluating handmade kites. The cost of the kite making rulebook is \$5.00.

The Fighter Kite and Rokkaku Rulebook describes a variety of contests, fights, and battles for single-line maneuverable kites. The cost of the fighter rulebook is \$5.00.

Manuals

AKA produces various manuals and pamphlets for kite fliers and kite makers. Most of these are online and available for free download:

How to Fly a Kite is a basic introduction and overview of kite flying techniques, wind and weather, types of kites, and safety. The cost of the manual is \$2.00.

The AKA Kite Events Manual provides instruction on how to organize and manage different types of kite festivals and competitions. The cost is \$6.00.

Kites in the Classroom explains how to give a classroom presentation about kites and how to organize kite making workshops. Plans are provided for many different kinds of kites. The cost is \$5.00 for a hard bound copy. It can be downloaded from the web for free.

The AKA Kite Club Manual provides information on how to organize and manage a local kite club. The cost is \$5.00.

Professor Kite and the Secret of Kites is a simple, one page leaflet on single and multi-line kite flying. The cost is \$8.00 for 100 leaflets.



For additional copies of this publication contact:

American Kitefliers Association

P. O. Box 1614

Walla Walla, WA 99362, USA

Email: aka@aka.kite.org